



WELDING PERFORMANCE of CARBON STEEL COVERED WITH 316L STAINLESS STEEL USING GTAW PROCESS

A. Soudy^{1*}, W. Hoziefa², N. Fatahalla¹, K. M. Hafiz³

¹Mechanical Engineering Department, Faculty of Engineering, Al Azhar University, Cairo-Egypt

²Mining and Petroleum Department, Faculty of Engineering, Al Azhar University, Cairo-Egypt P.O. Box 11884

³Welding and NDT Lab., CMRDI, Cairo, Egypt.

*Correspondence: Araby@epic-me.net

Citation:

A. Soudy, W. Hoziefa, N. Fatahalla and K.M. Hafiz, "Welding performance of carbon steel covered with 316L stainless steel using gtaw process", Journal of Al-Azhar University Engineering Sector, vol. 19, pp. 212- 225, 2024.

Received: 19 Mrch 2024

Revised: 10 June 2024

Accepted: 27 June 2024

DOI: 10.21608/aej.2024.278099.1638

Copyright © 2024 by the authors. This article is an open-access article distributed under the terms and conditions of Creative Commons Attribution-Share Alike 4.0 International Public License (CC BY-SA 4.0)

ABSTRACT

A carbon steel ASTM 235JR covered with 4 mm layer of 316L stainless steel was welded using GTAW process. Two procedures were applied. The first one is to start welding of 316L layer using AWS A5.9 ER316Lfiller and then deposit of carbon steel using AWS A5.18 ER70S-6 filler wire on the 316L stainless steel weld metal. The other one is to weld the carbon steel substrate first and then deposit 316L stainless steel using AWS A5.9 ER316Lfiller on carbon steel weld metal. Starting from stainless steel side followed by deposition of carbon steel weld metal on 316L weld metal resulted in a joint with unaccepted bending test and v-notch impact toughness results. The microstructure at the interface of the joint welded with this procedure shows the existence of grain boundary type-II cracking and martensite layer. The average micro-hardness of the martensite layer is about 380 HV. The other procedure shows accepted bending and v-notch toughness results. This can be attributed to the absence of grain boundary type-II cracking at the interface of the welded joint using this procedure as observed at the microstructure of this zone. A martensite layer with micro-hardness value of 380 HV is also observed using this procedure. These results prove that the unacceptable bending and impact results is due to the formation of grain boundary type II cracking and not the formation of martensite structure.

KEYWORDS: carbon steel covered with 316L stainless steel, welding procedures, mechanical properties, microstructure, grain boundary type II cracking.

اختبار أداء لحام الصلب الكربوني المغطى بطبقة من الصلب المقاوم للصدأ باستخدام عملية اللحام بالكترود من التنجستين في وجود غاز خامل

عربي صلاح^{1*}، وائل حذيفة²، نبيل فتح الله¹، محمد حافظ³

¹قسم الهندسة الميكانيكية، كلية الهندسة، جامعة الأزهر، القاهرة-مصر.

²قسم هندسة التعدين والبتترول كلية الهندسة جامعة الأزهر القاهرة، مصر ص.ب. صندوق بريد ١١٨٨٤،

³معمل اللحام والاختبار الإئتلاف، CMRDI، القاهرة، مصر.

*البريد الإلكتروني للباحث الرئيسي : Araby@epic-me.net

الملخص

تم لحام الصلب ASTM 235JR المغطى بطبقة من الصلب المقاوم للصدأ 316L ذو تخانة ٤ مم مستخدمًا طريقة اللحام بالكترود من التنجستين في وجود غاز الأرجون-GTAW. تم تطبيق أساليب لإجراء اللحام أحدهما يبدأ باللحام التقابلي لطبقة

الصلب المقاوم للصدأ 316L مستخدماً سلك لحام AWS A5.9 ER316L ثم ترسيب طبقات من الصلب الكربوني عليه مستخدماً سلك لحام AWS A5.18 ER70S-6 أظهرت نتائج التني والصدم أنها غير مقبولة باستخدام هذا الأسلوب من إجراءات اللحام. أظهرت البنية المجهرية للخط الفاصل ما بين الصلب الكربوني والصلب المقاوم للصدأ وجود طبقة ذات مقياس صلادة يصل إلى ٣٨٠ فيكرز وبها أطوار المارتنيسيت كما أظهرت وجود شروخ من النوع grain boundary type-II. أما بالنسبة لأسلوب إجراءات اللحام الآخر فيتم استخدام سلك لحام AWS A5.18 ER70S-6 في ترسيب طبقات من الصلب الكربوني ثم يتم ترسيب طبقات من الصلب المقاوم للصدأ 316L عليه مستخدماً سلك لحام AWS A5.9 ER316L. أظهرت نتائج التني والصدم أنها مقبولة باستخدام هذا الأسلوب من إجراءات اللحام. أظهرت البنية المجهرية للخط الفاصل ما بين الصلب الكربوني والصلب المقاوم للصدأ وجود طبقة ذات صلادة تصل إلى ٣٨٠ فيكرز و بها أطوار المارتنيسيت كما أظهرت عدم وجود أي شروخ من النوع grain boundary type-II. وهذه النتائج تؤكد أن وجود طبقة المارتنيسيت ذات الصلادة التي تصل إلى ٣٨٠ فيكرز لا تؤثر على فشل الخواص الميكانيكية للوصلة، ولكن وجود الشروخ من النوع Grain boundary type-II. **الكلمات المفتاحية:** لحام الصلب الكربوني المغطى بطبقة من الصلب المقاوم للصدأ 316L، أساليب إجراءات اللحام، اختبار التني الجانبي، اختبار الصدمة، البنية المجهرية، اختبار الصلادة.

1. INTRODUCTION

Covering carbon steel with a thin layer to prevent corrosion such as stainless steel, nickel alloy and zirconium is beneficial to reduce the cost and having good corrosion resistance at the covering surface [1-6]. Many methods are applied to cover the carbon steel include rolling, explosion covering and weld overlay [2]. Covering thickness ranges from 5 to 50 percent of the total thickness [1-9].

Welding of steel covered with corrosion resistance alloy (clad steel) pipes depends on which side welding is possible. If the weld can be done from the cladding side, then the carbon steel is welded with the corresponding filler metal and then the last two passes are welded by filler metal matched with clad material. If the joint must be welded from the carbon steel side (as in case of small diameter pipe), then first the high alloy cladding must be welded. Then a problem arises once it is not possible to weld carbon steel filler metal on high alloy base metal, because this would result in a layer of high alloy martensitic weld metal with cracking [1, 2, 10-12]. A possible solution to this problem is welding with nickel base filler metal as described in literature [2-4].

Cracking in dissimilar welding occurs near the fusion boundary along the martensite layer or along the type II boundary [13]. A model was investigated between iron base metal and Monel alloy weld metal [14]. Evolution of grain boundary on cooling transformations in fusion zone and HAZ was also illustrated [14].

Cracks occurred in the Inconel 625 fusion zone between the Inconel 2nd pass and 3rd pass (carbon steel) and not in martensitic zone [15-16]. Also, a welding technique was applied in which AWS 5.11 ENi-1 electrode is used to weld the third pass on Inconel 625 weld metal followed by AWS A5.1 E7018 to weld the fourth pass and the remaining passes. This technique improved the impact strength with no need for PWHT [16].

The aim of the present research work is to study the weldability of carbon steel covered with AISI316L stainless steel with GTAW process using two techniques. Firstly, start welding of 316L layer side using AWS A5.9 ER316L filler and then deposition of carbon steel on austenitic stainless steel weld metal to finish welding of carbon steel side. Secondly, start welding of carbon steel substrate side ended with deposition of 316L stainless steel on carbon steel weld metal to finish welding of stainless-steel side. The influence of using each technique on the mechanical and metallurgical properties of the joints was investigated.

2. Experimental work

2.1. Materials

2.1.1 Base Metal:

A carbon steel of EN10025 grade S235JR steel 6 mm thickness and clad with 4 mm thickness of 316L stainless steel. The chemical composition is shown in Table 1. Filler wires which are shown in Table 1 were used.

2.2 Welding procedure

GTAW process was applied in this procedure using amperage of 130 A and a voltage of 26 V. A 2.4 mm diameter of 2% thorium tungsten electrode is applied.

2.3. Mechanical tests

Tension test: Two transverse test specimens were selected and prepared as shown in Fig. 1.

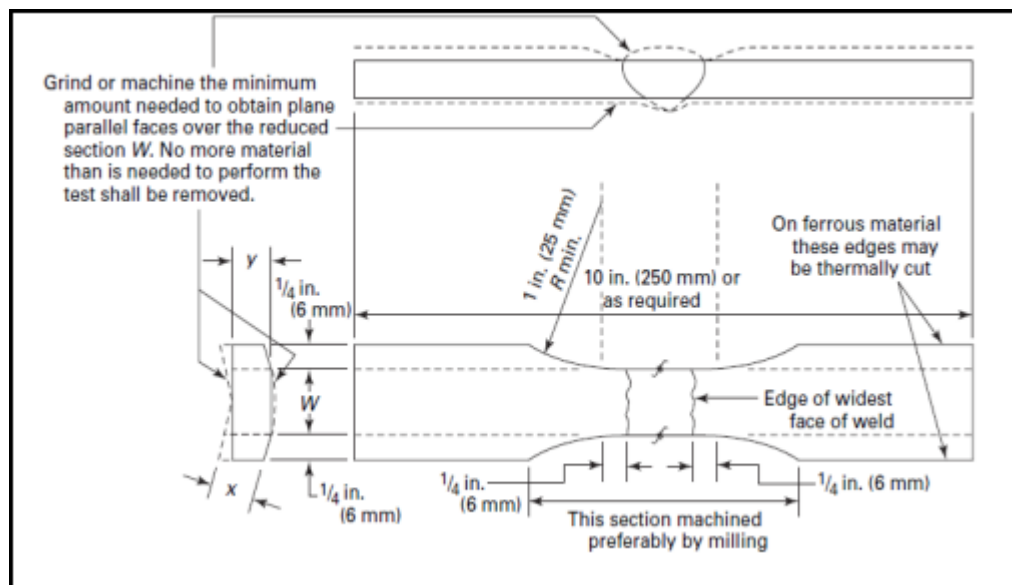
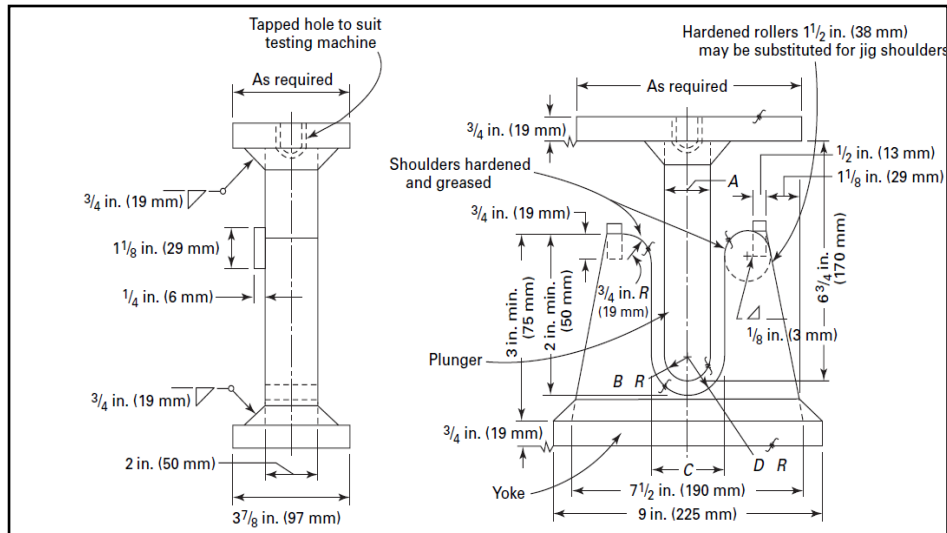

Fig. 1 Tensile test specimen details according to ASME IX-2007, where W is specimen width (19 mm), x is coupon thickness including reinforcement and y is specimen thickness.

Bend test: Four specimens for transverse side bend test were selected and prepared with 10 mm thickness. The specimen dimensions and bend radius are shown in Fig.2.



Name	A	B	C	D	Thickness
Dimension (mm)	38.1	19	60.4	30.2	10

Fig.2 point bend test jig dimensions

Notch-Toughness Tests: Impact testing was done using Charpy impact V-notch method and according to ASTM A 370-97 standard. The specimen dimensions are sketched in Fig.3, where specimen size is 55×10×10 mm³. The locations of test specimen are at the middle of the weld metal perpendicular to the direction of welding.

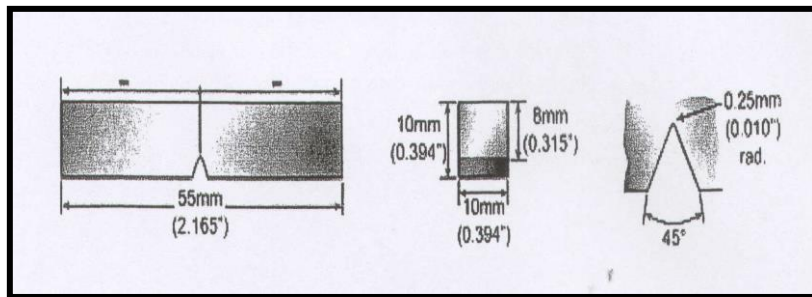

Fig. 3 Charpy V-notch test piece dimensions for full sized specimens

2.4 Microstructure and microhardness characterization

Microstructure is observed at the cross section after grinding, polishing and etching. Etching was done using mixture of HNO₃, HCl, acetic acid and drops of glycerol. The etched specimen was observed with an optical microscope. The microhardness measurements were conducted using Shimadzu microhardness equipment with a load of 100 g.

Table 1- Chemical composition of base and filler metals (wt %)

Element	EN10025 grade 235JR	316L cover layer	AWS A5.9 ER316L filler	AWS A5.18 ER70S-6 filler
Fe	Bal.	Bal.	Bal.	Bal
Cr	0.011	17.2	17	---
Ni	0.011	12	12	0.03
Mn	1.45	2	2.1	1.65
Si	0.22	0.2	0.1	0.8
Mo	0.228	2.45	2.5	0.15
Cu	0.013	----	----	---
Ti	0.1	----	----	0.001
V	0.072	----	----	---
Nb	0.008	0.3	0.2	---
C	0.13	0.028	0.03	0.15
Al	0.008	----	----	0.01
P	0.01	0.01	0.02	0.016
S	0.02	0.02	0.02	0.01

Results and discussion

3.1 Chemical and mechanical properties of base metal

Chemical composition of base and filler metals is listed in Table 1.

The mechanical properties of EN10025 grade S235JR that covered with 316L stainless steel are presented in Table 2. These values of mechanical properties are used as acceptance criteria to evaluate welding procedures.

Table 2 Average mechanical properties of base metal.

Yield Strength (N/mm²)	Tensile Strength (N/mm²)	Impact toughness at -20 °C (Joule)
247	510	50

3.2 Fusion welding with deposition of carbon steel on stainless steel weld metal

In this welding procedure welding is started from the stainless steel using two passes (clad side) followed by gouging from carbon steel side and then deposition of carbon steel weld metal on stainless steel weld metal. The mechanical and metallurgical properties of the joint are discussed in the following sections.

3.2.1. Mechanical Properties

According to ASME SEC. IX, the mechanical properties which are needed to evaluate this welding procedure are tensile strength, side bend test and impact notch toughness. These mechanical properties are reported in Tables 3, 4, and 5 respectively. It is clear that the average ultimate tensile strength is 504 N/mm², which is accepted. The test specimens are accepted when the minimum tensile strength of the base metal is achieved. However, the side bend test, which provides an indication of the ductility of the welds, gave unaccepted results as shown in Table 4. The specimen is accepted when no open discontinuity in the weld or heat-affected zone exceeding 3 mm is observed on the convex surface of the specimen after bending. The average impact notch toughness value of specimens is as low as 22 Joule (see Table 5), which is not acceptable. The acceptance criteria are that: the minimum average (set of three specimens) absorbed energy is 27 J and the test temperature shall be -20°C.

Table 3- Tensile test results for deposition of carbon steel on stainless steel weld metal

Specimen No.	Ultimate Tensile Stress (N/mm²)	Failure Location	Evaluation
1	503	W.M	Accepted
2	505	W.M	Accepted

Table 4-Side bend test results for deposition of carbon steel on stainless steel weld metal

Position	WM				
	1	2	3	4	5
Weld metal	24	22	20	21	25

Table 5 -Impact V-notch toughness (Joule) at -20 oC for deposition of carbon steel on stainless steel weld metal

Specimen No.	Type of Bend	Evaluation
1	Side	Rejected
2	Side	Rejected
3	Side	Rejected
4	Side	Rejected

3.2.2 Microstructure and micro-hardness at the joint welded with deposition of carbon steel on stainless steel weld metal

Fig. 4 shows the microstructure of carbon steel. It is ferrite-pearlite phases. On the other hand, Fig. 5 shows the microstructure of the 316L stainless steel side. It is austenitic grain phases with twin structure.

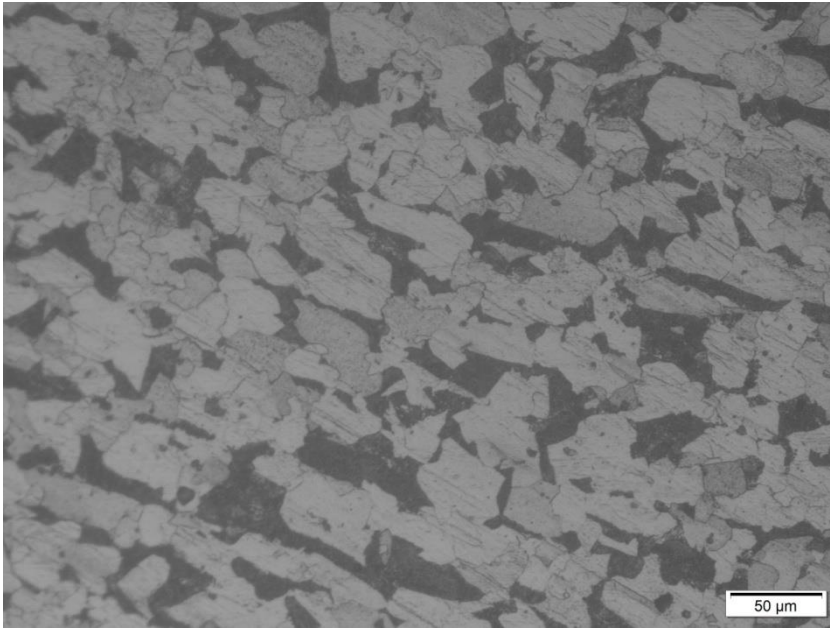

Fig. 4 Microstructure of the carbon steel (ferrite and pearlite phases)

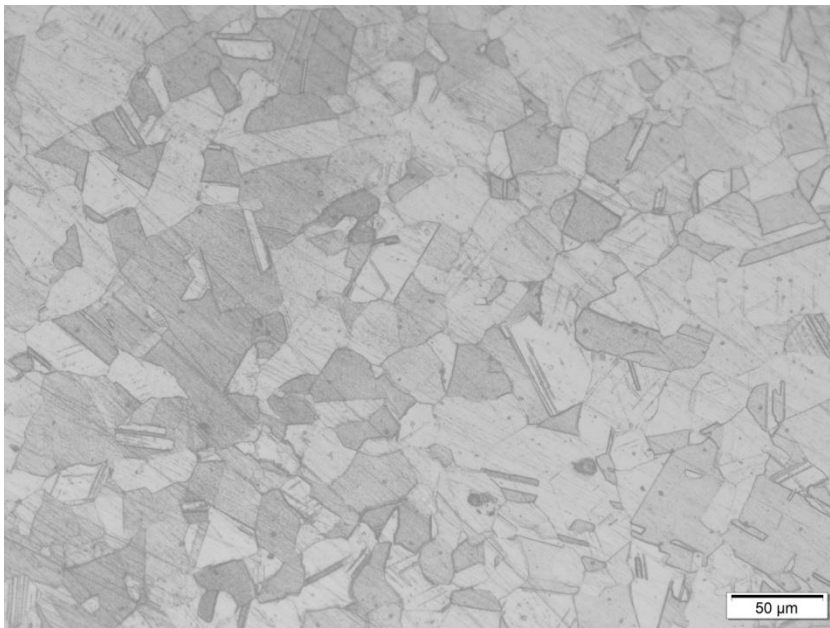

Fig. 5 Microstructure of 316 L stainless steel layer show the dual phases

The microstructure zones that exist between dissimilar welds as illustrated schematically in Fig.6 as follows [4]:

- Fusion zone (FZ) or complete mixing zone (CMZ): The fusion zone is the region where complete mixing occurs between carbon steel filler metal and stainless steel 316L and the composition is macroscopically uniform.
- Partially mixed zone (PMZ): the region where the composition is gradually changed from that of the complete mixing zone to that of base metal.

- Partially melted zone: the region where the peak temperatures fall between the liquidus and solidus so that melting is incomplete and re-solidified without any mixing.
- Transition Region: the Region which includes partially melted and partially mixed zones.

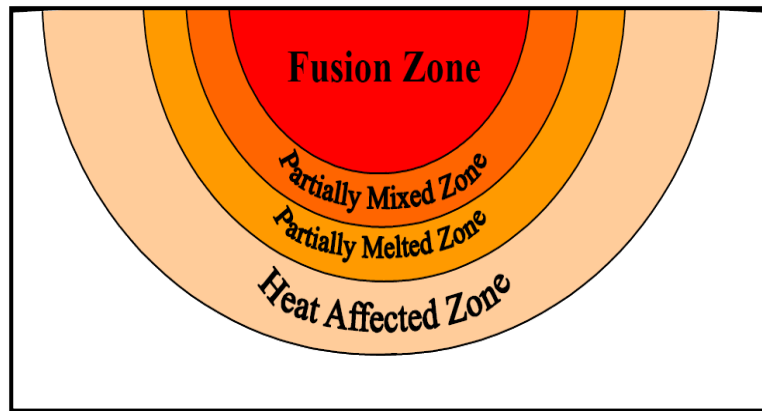

Fig.6 Schematic illustrates the five distinct microstructural zones that exist in dissimilar welds [4].

Figure 7 shows the microstructure at the interfaces between the stainless-steel weld metal and the carbon steel weld metal. In all the figures, there are martensitic structures. Hardness measurements gave an average value of 380 HV at the martensite layer. The existence of martensite layer is expected as described by Rowe et al [12]. They found many cracks and they may mistake the reason for the occurrence of such cracks as they are hydrogen induced cold cracking.

Using Schaeffler diagram as shown in Fig.8 give evidence of such expectation where the martensite layer is formed. In Fig. 7, there are many cracks which are named grain boundary type II cracking [15, 16].

These cracks affect the unacceptable results of side bending test and v-notch impact toughness test of this joint. The same results were obtained by Morsy et al [16] in deposition of carbon steel weld metal on Inconel 625 weld metal.

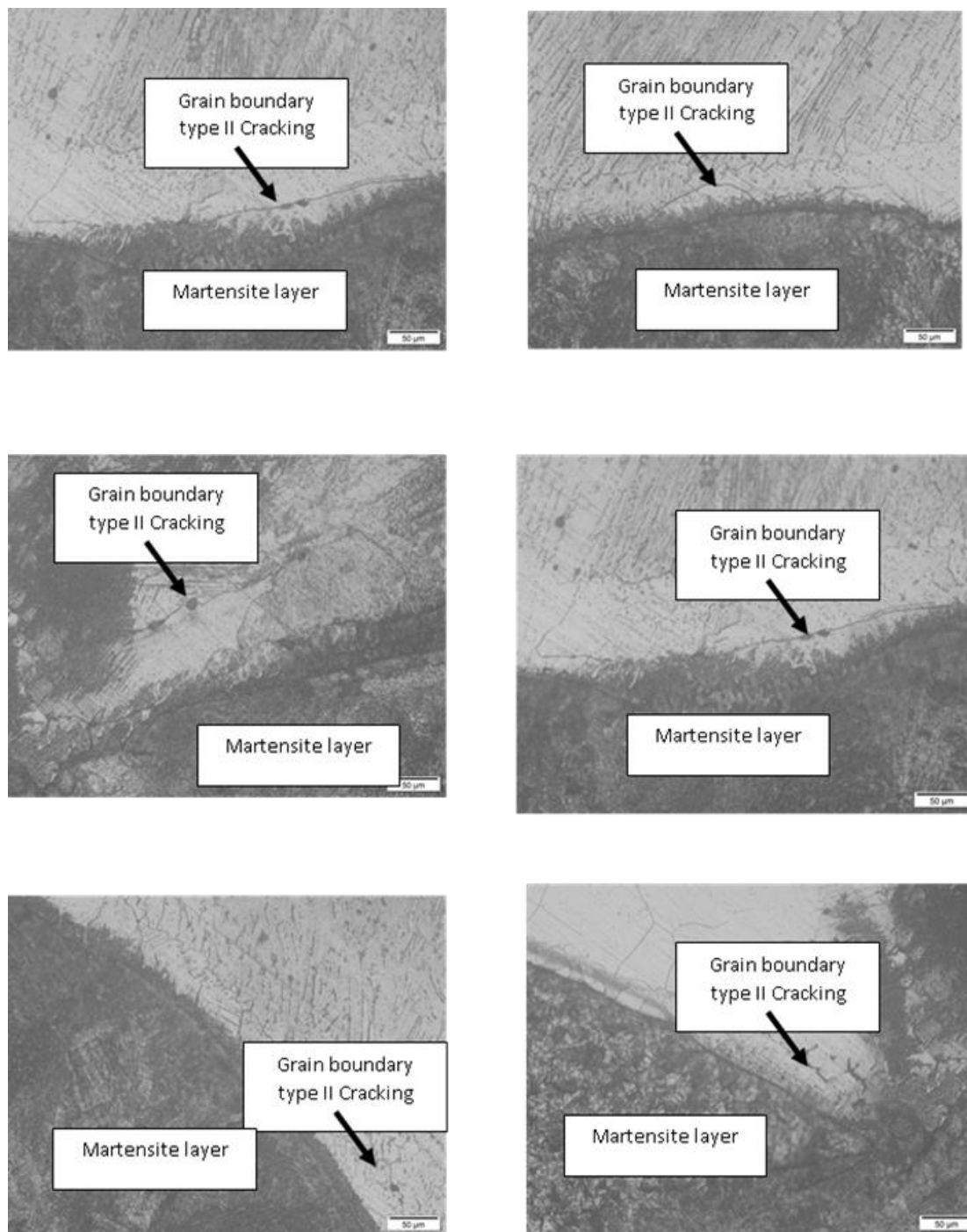

Fig.7 Microstructures at the interface between the weld metal of 316L layer and deposited carbon steel layer that shows the existence of grain boundary type II cracking at different locations.

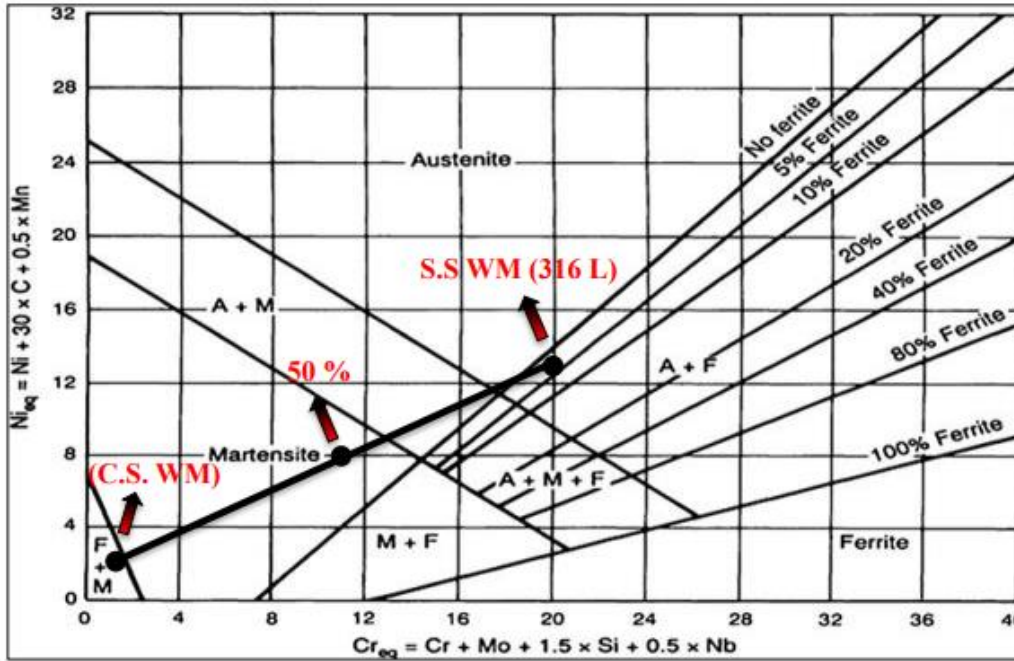

Fig. 8 Scheffler diagram showing the 316L weld metal (WM) and the deposited carbon steel (CS). The point of 50% dilution shows the phases expected.

3.3 Fusion welding with deposition of stainless steel on carbon steel weld metal

In this welding procedure the welding is started from the carbon steel side using four passes (substrate side) followed by gouging from stainless steel side and then

deposition of stainless steel on carbon steel weld metal. The mechanical and metallurgical properties of the joint are discussed in the following sections.

3.3.1. Mechanical Properties

According to ASME SEC IX, the mechanical properties which are needed to evaluate this welding procedure are tensile strength, side bend test and impact notch toughness. These mechanical properties are reported in Tables 6, 7, and 8 respectively. The average ultimate tensile strength is 525 N/mm², which is accepted. The side bend test, which provides an indication on the ductility of the welds, gave accepted results. The average impact notch toughness value of specimens is about 45 Joule (see Table 8), which is acceptable.

Table 6- Tensile test results for deposition of carbon steel on stainless steel weld metal

Specimen No.	Ultimate Tensile Strength (N/mm ²)	Failure Location	Evaluation
1	525	W.M	Accepted
2	526	W.M	Accepted

Table 7-Side bend test results for deposition of carbon steel on stainless steel weld metal

Specimen No.	Type of Bend	Evaluation
1	Side	Accepted
2	Side	Accepted
3	Side	Accepted
4	Side	Accepted

Table 8 -Impact V-notch toughness (Joule) at -20 oC for deposition of stainless-steel weld metal on carbon steel

Position	WM				
	1	2	3	4	5
Weld metal	45	46	44	47	43

3.3.2 Microstructure and micro-hardness at the joint welded with deposition of stainless-steel on carbon steel weld metal

Figure 9 shows the microstructure at the interface of the welded joint with deposition of stainless steel on carbon steel weld metal. The interface is free from any cracks. Hardness measurements gave an average value of 380 HV at the martensite layer.

Although the existence of martensite layer with high hardness values, the bending and v-notch impact test were accepted. This proved that the failure of bending, and toughness test is related to the existence of grain boundary type II cracking. Thus, the welded joint with deposition of stainless steel on carbon steel weld metal procedure prevents the occurrence of grain boundary type II cracking. However, in welding of small diameter pipe that covered at the inner surface with corrosion protection 316L-austenitic layer this procedure cannot be applied. Instead, it is advised to start welding using ER316 L steel filler metal at the root passes and complete welding using the

same austenitic filler wire until finishing the welding process to the cap (welding of austenitic stainless steel on carbon steel technique). There is an extra cost added because of using stainless steel instead of carbon steel filler metal.

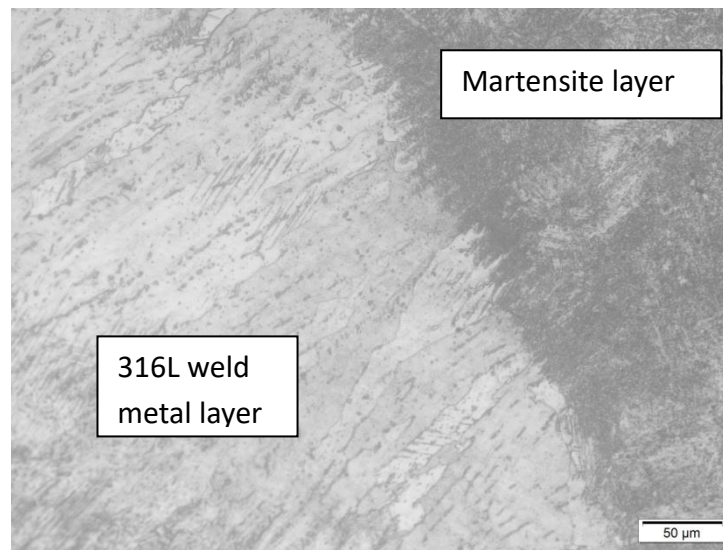

Fig. 9 Microstructure at the interface of the welded joint with deposition of stainless steel on carbon steel weld metal

The same results were observed in welding of carbon steel covered with Inconel 625[15]. Morsy et al [15] solved this problem in deposition of carbon steel at Inconel 625 layer by lowering the martensitic start temperature (TMS) of the martensite layer that formed at the interface. Another method was also investigated in which a pure nickel layer was deposited between the Inconel 625 layer and the subsequent carbon steel deposited layer that prevented the occurrence of this type of crack [16].

Conclusion

The weldability of carbon steel covered with 316L stainless steel was investigated using GTWA process and applying two procedures. The following conclusions can be withdrawn:

1. Deposition of carbon steel on 316 stainless steel weld metal gave unaccepted bending and V-notch impact toughness results. Microstructure showed the existence of grain boundary type II cracking at the interface between the carbon steel weld metal and stainless-steel weld metal. The average hardness value of the formed martensitic layer at the interface is about 380 HV.
2. Deposition of 316 stainless steel weld metal on carbon steel weld metal gave accepted bending and V-notch impact toughness results. Microstructure showed the absence of grain boundary type II cracking at the interface between the carbon steel weld metal and stainless-steel weld metal. The average hardness value of the formed martensitic layer at the interface is also close to 380 HV.
3. The unaccepted results of bending and V-notch impact toughness are due to the generation of grain boundary type II cracking and not due to the formation of high hardness martensitic region.

References

- [1] Inker, Lng. "International Course of Welding Engineer; part 1: Welding process and equipment". Institute in the Germany Welding Society. P398. (2003).
- [2] ASM Handbook Committee. "Effect of Transformations on Transient Weld Stresses, Section: Fundamentals of Welding; Volume 6 of Welding, Brazing, and Soldering". Electronic copy of ASM Handbook. (1999).
- [3] Payares-Asprino, M., Katsumoto, H, and Liu, S. "Effect of Martensite Start and Finish Temperature on Residual Stress Development in Structural Steel Welds" *Welding Journal*, Vol. 87. P279- 289. (2008).
- [4] Henrik Alberg., "Simulation of Welding and Heat Treatment Modelling and Validation". Ph.D, Division of Computer Aided Design Department of Applied Physics and Mechanical Engineering; Lulea University of Technology. Sweden. (2005).
- [5] Jae Lee and Chester J. Van Tyne. "Kinetics Model for Martensite Transformation in Plain Carbon and Low-Alloyed Steels". Volume 43A of *Metallurgical and Materials Transactions*. P422-427. (2010).
- [6] Seok-Jae Lee and Young-Kook Lee. "Finite Element Simulation of Quench Distortion in a Low-Alloy Steel Incorporating Transformation Kinetics" .Elsevier Ltd. *Acta Materialia* 56 (2008). P 1482–1490.
- [7] Capdevila, C., Caballero, F. García de Andrés, C. "Dependence of Martensite Start Temperature on Fine Austenite Grain Size". Madrid, Spain. Material Research Group; Department of Physical Metallurgy. <http://www.cenim.csic.es> (accessed at 3/12/2012).
- [8] ASM Handbook Committee. "Selection of Wrought Martensitic Stainless Steels; Volume 6 of Welding, Brazing, and Soldering". Electronic copy of ASM Handbook. (1999).
- [9] Dupont, J. and Kusko, C. "Technical Note: Martensite Formation in Austenitic/Ferritic Dissimilar Alloy Welds". *Welding Journal*. P51-56. (2007).
- [10] Amir Malakizadi. "Simulation of Cooling Behavior and Microstructure Development of PM Steels". Diploma work No. 42/2010 Department of Materials and Manufacturing technology Chalmers University of Technology. Gothenburg, Sweden. Gothenburg. P9-10. (2010).
- [11] Abdullah, M., and Mohammed, A. "Environmental Cracking of Dissimilar Metal Welds". *Saudi Aramco Journal of Technology*. P1-2. (2008).
- [12] Rowe, M., Nelson, T. and Lippold, J. "Hydrogen-Induced Cracking along the Fusion Boundary of Dissimilar Metal Welds". *Welding Journal Supplement*, P31-37 (1999).
- [13] Nelson, T., Lippold, J. and Mills, M. "Nature and Evolution of the Fusion Boundary in Ferritic-Austenitic Dissimilar Weld Metals; Part 1: Nucleation and Growth". *Welding Journal Supplement*. P329-337. (1999).
- [14] Nelson, T., Lippold, J. and Mills, M. "Nature and Evolution of the Fusion Boundary in Ferritic-Austenitic Dissimilar Weld Metals; Part 2: On-Cooling Transformations" .*Welding Journal Supplement*. P267-277. (2000).
- [15] M. A. Morsy, M.R. EL Koussy and M. M. Farag "Prevent Cracking in Deposition of Carbon steel on Inconel 625" *MATEC Web of conferences* 269 (5) : 03011 (2019).
- [16] M. A. Morsy and M. R. El Koussy "Effect of deposition of pure nickel cushion layer on crack along type II boundary formed on deposition of carbon steel on nickel base alloy" 72nd Annual Assembly and International conference 7-12 July 2019, Bratislava.